

# CP-302

**MIG Welding  
Power Source** 

## Quick Specs

### Industrial Applications

Light fabrication  
Automotive  
Furniture  
Agricultural  
Truck body/metal fabrication  
Small equipment manufacturing

### Processes

MIG (GMAW)  
Flux-cored (FCAW)

**Input Power** 3-phase power

**Rated Output** 300 A at 32 V, 100% duty cycle  
390 A at 32 V, 60% duty cycle

**Max. Open-Circuit Voltage** 14–44 VDC

**Net Weight** 332 lb. (151 kg)

**Adjustable weld stabilizer** (high-low inductance) provides the flexibility to produce the optimal arc characteristics. Use the high stabilizer setting for stainless steel and low setting for mild steel and aluminum.

**Solid-state weld contactor** provides longevity to match the ultra-durable and reliable reputation of the CP series.

**Power efficient** for exceptional value and return on your investment.

**115 VAC duplex receptacle** provides 15 amps of auxiliary power.



Build your own system at [MillerWelds.com/equiptoweld](http://MillerWelds.com/equiptoweld) or see the **stationary and MIGRunner packages** (page 3).

**Large analog volt and ammeters** for easy viewing.

**Presetable welding voltage** with voltmeter allows you to easily set weld output before welding.

**Simple control panel** with just one control adjustment.

**Lower panel cover** protects output connections from harsh welding environments.

**14-pin receptacle** provides quick, direct connection to wire feeders and accessories.

**CP-302 MIGRunner™ package shown.**



Welder is warranted for three years, parts and labor.  
Original main power rectifier parts are warranted for five years.



**Miller Electric Mfg. Co.**  
An ITW Welding Company  
1635 West Spencer Street  
P.O. Box 1079  
Appleton, WI 54912-1079 USA

**Equipment Sales US and Canada**  
Phone: 866-931-9730  
FAX: 800-637-2315  
International Phone: 920-735-4554  
International FAX: 920-735-4125

**MillerWelds.com**  



# Specifications (Subject to change without notice.)



Voltage Range	Rated Output	Amps Input at Rated Output, Three-Phase, 60 Hz						Open-Circuit Voltage	Dimensions	Net Weight
		200 V	230 V	460 V	575 V	KVA	KW			
14-44 V	300 A at 32 V, 100% duty cycle	38	33	16.5	13.0	13.1	12.3	14-44 VDC	H: 30 in. (762 mm) (including lift eye) W: 23 in. (585 mm) D: 30.5 in. (775 mm) (including strain relief)	332 lb. (151 kg)
	390 A at 32 V, 60% duty cycle	1.1*	.95*	.48*	.38*	.38*	.32*			

\*While idling.

Certified by Canadian Standards Association to both the Canadian and U.S. Standards.

Conforms with NEMA EW 1, "Electric Arc Welding Power Sources", Class I (100).

## Control Panel

- 1. Ammeter
- 2. Voltmeter
- 3. Power Switch
- 4. Pilot Light
- 5. Preset Indicator Light
- 6. Voltage Control

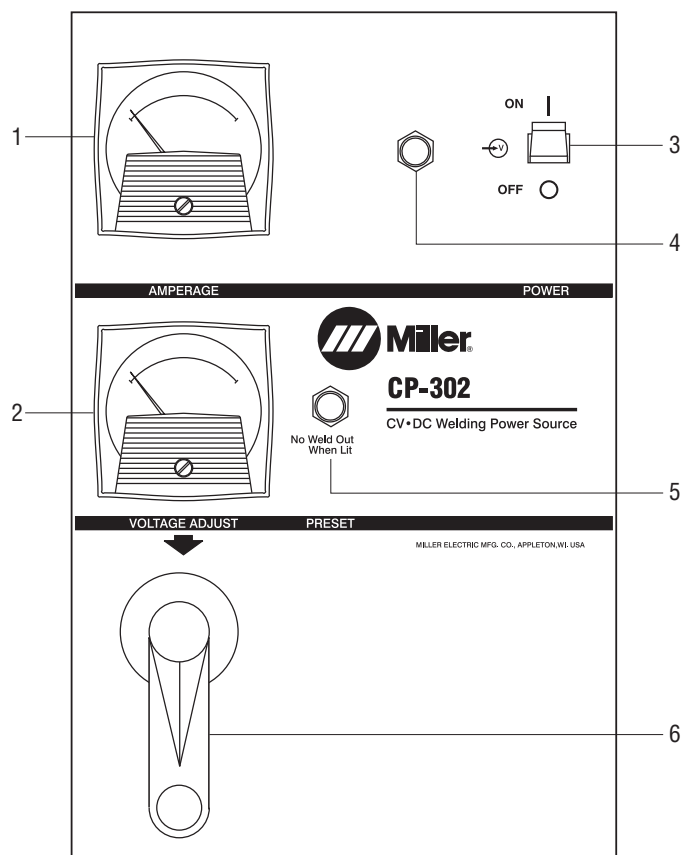

## Performance Data

Duty Cycle Chart

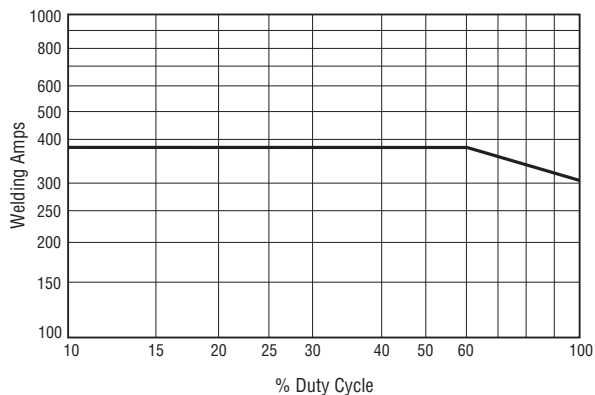

Volt/Amp Chart

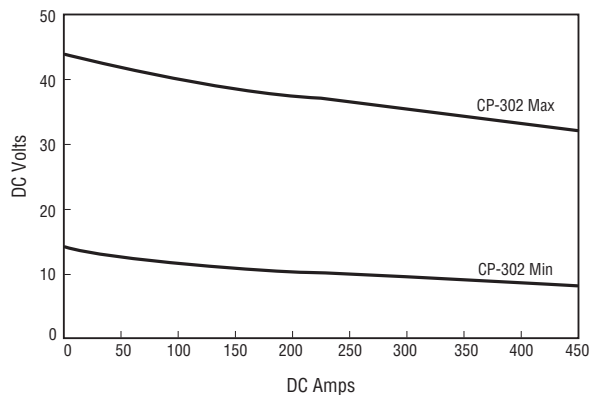

## Packages



### Option #1: CP-302 Power Source Only

Purchase components separately.

**CP-302 903786**



Build your own system at  
[MillerWelds.com/equiptoweld](http://MillerWelds.com/equiptoweld)



### Option #2: CP-302 Stationary Package

Stationary display without running gear or cylinder rack.

**CP-302 Stationary Package 951231**

#### Comes complete with:

- CP-302 power source
- 22A wire feeder
- Bernard™ BTB Gun 300 A
- Industrial MIG 4/0 kit consisting of flowmeter regulator with 10 ft. (3 m) gas hose, 10 ft. (3 m) 4/0 feeder weld cable with lugs, and 15 ft. (4.6 m) work cable with 600-amp C-clamp



### Option #3: CP-302 MIGRunner™ Package

MIGRunner system with factory-installed standard running gear and cylinder rack.

**CP-302 MIGRunner Package 951230**

#### Comes complete with:

- CP-302 power source
- 22A wire feeder
- Bernard™ BTB Gun 300 A
- Industrial MIG 4/0 kit consisting of flowmeter regulator with 10 ft. (3 m) gas hose, 10 ft. (3 m) 4/0 feeder weld cable with lugs, and 15 ft. (4.6 m) work cable with 600-amp C-clamp
- Factory-installed standard running gear and cylinder rack

## Genuine Miller® Accessories



### Industrial MIG 4/0 Kit 300390

Includes flowmeter regulator with 10-foot (3 m) gas hose, 10-foot (3 m) 4/0 feeder weld cable with lugs, and 15-foot (4.6 m) work cable with 600-amp C-clamp.



### WC-24 Weld Control 137549

Packaged in a compact, lightweight, non-metallic enclosure, the WC-24 easily mounts directly on the power source. It's designed for use with Miller CV power sources supplying 24 VAC and 14-pin receptacles. The control includes a board-mounted potentiometer which can alter the drive motor acceleration rate to optimize arc starting performance.



### Standard Running Gear 042886

The large 10-inch (254 mm) rear wheels and 5-inch (127 mm) front casters on this running gear provide excellent mobility on the shop floor, making it easier to move the power source. Very easy to install. Handles double as weld cable holder.

### Standard Cylinder Rack 042887

Holds two cylinders. Only installs on standard running gear **042886**.

## Wire Feeder Options

### Bench-Style Feeders

22A  
S-74S

### Literature

M/11.0  
M/3.0

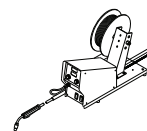

### Bench-Style Dual Feeders

D-74S

M/3.0

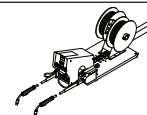

### Boom-Style Feeders

SS-74S12  
SS-74S16

M/13.11  
M/13.11

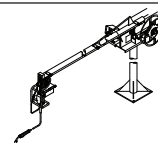

### Boom-Style Dual Feeders

DS-74S12  
DS-74S16

M/13.11  
M/13.11

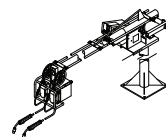

### Spool Guns

Spoolmatic® 15A  
Spoolmatic® 30A

M/1.73  
M/1.73

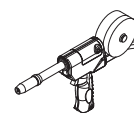

## Ordering Information

Equipment and Options	Stock No.	Description	Qty.	Price
CP-302 Power Source Only	903786	200/230/460 V, 60 Hz		
CP-302 Stationary Package	951231	200/230/460 V, 60 Hz		
CP-302 MIGRunner™ Package	951230	200/230/460 V, 60 Hz		
<b>Wire Feeders</b>				
22A	951190	See literature M/11.0		
70 Series	951196 951203	S-74S. See literature M/3.0 D-74S. See literature M/3.0		
Swingarc™ Boom Feeders		See literature M/13.11		
Extension Cables for 14-Pin Plugs to 14-Pin Sockets*	242208025 242208050 242208080	25 ft. (7.6 m) 50 ft. (15.2 m) 80 ft. (24.4 m)		
		<i>*For additional lengths visit MillerWelds.com/equiptoweld.</i>		
Spoolmatic® 15A	195156	See literature M/1.73		
Spoolmatic® 30A	130831	See literature M/1.73		
WC-24 Weld Control	137549			
<b>Guns</b>				
Bernard™ Gun/Consumables				
<b>Accessories</b>				
Industrial MIG 4/0 Kit	300390	Includes flowmeter regulator with 10 ft. (3 m) gas hose, 10 ft. (3 m) 4/0 feeder weld cable with lugs, and 15 ft. (4.6 m) work cable with 600-amp C-clamp		
Standard Running Gear	042886			
Standard Cylinder Rack	042887			

Date:

Total Quoted Price:

Distributed by:

